

LEFT SIDE VIEW

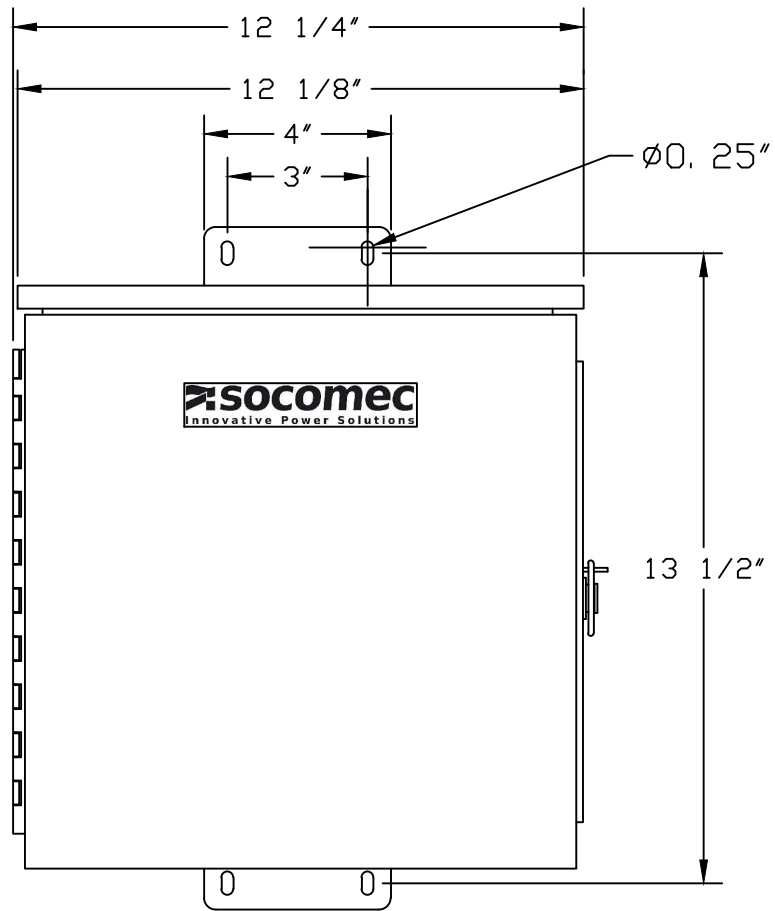

FRONT VIEW

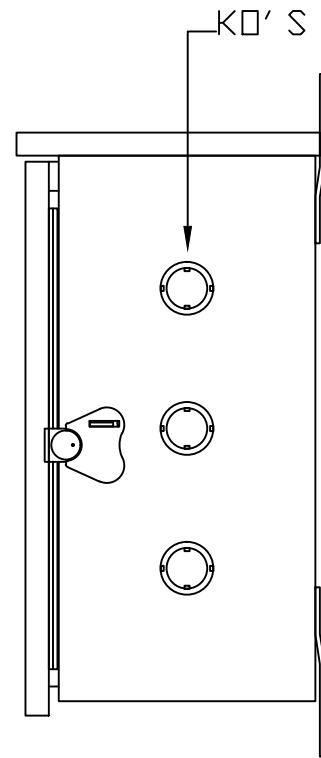

RIGHT SIDE VIEW

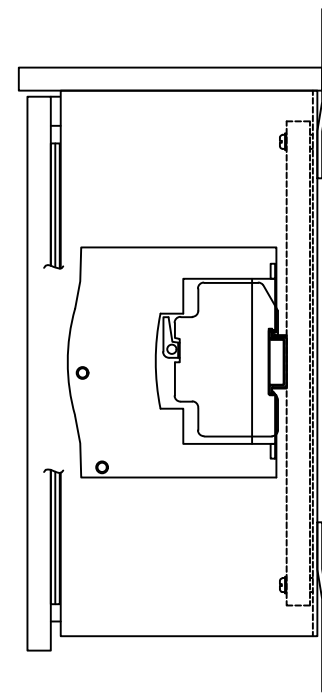

RIGHT SIDE VIEW  
CUTAWAY

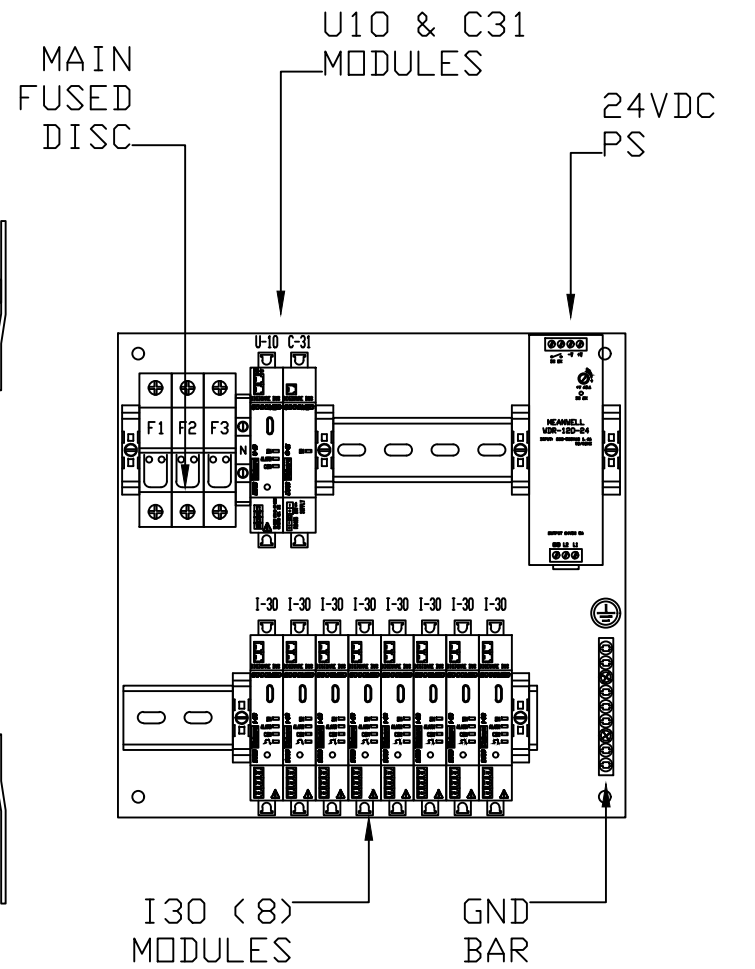

SUBPLATE LAYOUT

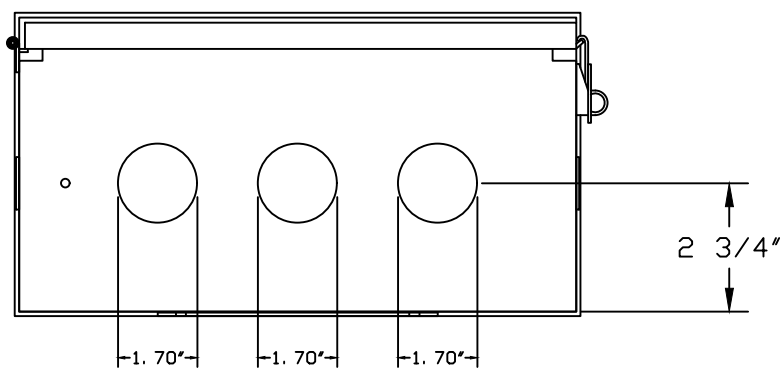

BOTTOM VIEW

- NOTES:  
 1- TYPE 3R ENCLOSURE.  
 2- 14GA STEEL CONSTRUCTION.  
 3- POWDER COATED, COLOR ANSI 49 GREY.

PART NUMBER:	DBB08NDO
DESCRIPTION:	U10, C31 MODULES, 8/I-30 MODULES & 24VDC PS
PROJECT:	SOCOMEK METERING PANELS - DIGIBOX-8 STYLE
CUSTOMER:	XXXX
ADDRESS:	XXXX
ADDRESS:	XXXX



DRAWING:	SOCOMEK METERING PANELS - DIGIBOX-8 STYLE - # DBB08NDO
SCALE:	NONE
DATE:	10-5-2017 (REV-0)
DRAWN BY:	LPC
CHECKED BY:	APN
DRAWING #:	SOCOMEK METERING PANELS - DIGIBOX-8 STYLE - # DBB08NDO - M1

REVISIONS	
REV-6	
REV-5	
REV-4	
REV-3	
REV-2	
REV-1	